

Compact Cylinder/Guide Rod Type
Kompaktzylinder mit Führungsstangen
Cilindro Antitrotazionale
Vérin Pneumatique
Cilindro Compacto Antitorsión

	Ø	Stroke	A	B	C	D	E	
CA.11.17.001	12	10	41.5	25	10	M5	M4	59 g
CA.11.17.002		20	51.5					77 g
CA.11.17.003	16	10	41.5	29	14		M6	97 g
CA.11.17.004		20	51.5					138 g
CA.11.17.005	20	10	50	36	17		M6	168 g
CA.11.17.006		20	60					186 g
CA.11.17.007	25	10	53.5	40	22		M6	223 g
CA.11.17.008		20	63.5					264 g
CA.11.17.009	32	10	60	45	28		G 1/8	309 g
CA.11.17.010		20	70					

Sensor: PNP = KT58PM8 or KT58P3M

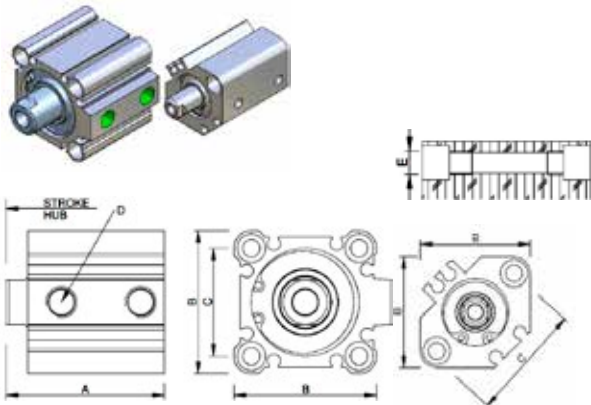

Compact Cylinder
Kompaktzylinder
Cilindro compatto
Vérin Pneumatique
Cilindro Compacto

	Ø	Stroke	A	B	C	D	E	
CA.11.18.001	12	10	42	25	15.5	M5	M4	44 g
CA.11.18.002		20	51.5					69 g
CA.11.18.003	16	10	44	29	20		M6	68 g
CA.11.18.004		20	54					89 g
CA.11.18.005	20	10	46	36	25.5		M6	106 g
CA.11.18.006		20	56					138 g
CA.11.18.007	25	10	47.5	40	28		M6	148 g
CA.11.18.008		20	57.5					186 g
CA.11.18.009	32	10	50	45	34		G 1/8	231 g
CA.11.18.010		20	60					285 g

Sensor: PNP = KT58PM8 or KT58P3M

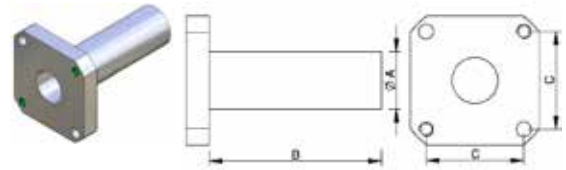

Adapter for Cylinder
Adapter für Kompaktzylinder
Staffa parallela per Cilindro
Bride pour Vérin Pneumatique
Montaje para el Cilindro compacto

	A	B	C	M*	
CA.ADZ.12.14	14	30	15.5	Ø12	19 g
CA.ADZ.16.14			19.9	Ø16	25 g
CA.ADZ.20.14		40	25.5	Ø20	32 g
CA.ADZ.25.20	20	60	28	Ø25	55 g
CA.ADZ.32.20			34	Ø32	74 g
CA.ADZ.32.20.90		25	60		



Cylinder Buffer
Druckplatte
Tamponne per cilindro
Tampon pour vérin
Tampón para pistón pequeño

	A	B	C	M*	
CA.11.04.001	20	M3	14	Ø12	5 g
CA.11.04.002	25	M4	15	Ø16	10 g
CA.11.04.003	30	M5	18	Ø20	17 g
CA.11.04.004	35	M6	19	Ø25	28 g
CA.11.04.005	40	M8	20	Ø32	46 g
CA.11.04.006	20	M5	14	KHZ/JDR	7 g
CA.11.04.007	40	G1/8	20		40 g

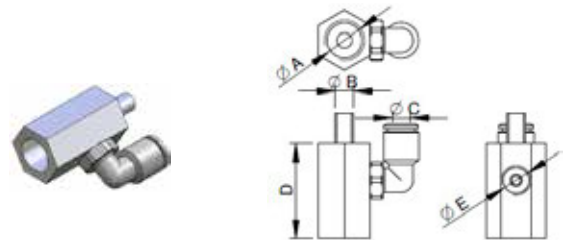

Adapter for vacuum cup
Adapter für Vakuumsauger
Collegamento cilindro per ventosa
Adaptateur pour ventouse
Adaptador para ventosa

	A	B	C	D	E	M*	
CA.11.15.001	G1/8	M4	4	24.5	M5	Ø16	13 g
CA.11.15.002		M6				Ø25	15 g
CA.11.15.003	G1/4	M5	6	31	G 1/8	Ø20	24 g
CA.11.15.004	G1/8		M8	4	34.5	M5	Ø20
CA.11.15.005	G1/4	M8	6	31	G 1/8	Ø32	22 g

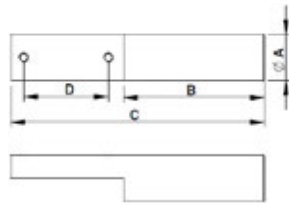

Adapter for Cylinder
 Adapter für Kompaktzylinder
 Staffa posteriore a L per cilindro
 Adaptateur pour vérin
 Adaptador para cilindro compacto

	A	B	C	D	M*	
CA.GAZ.12.10.60	10	60	98	21.9	Ø12	17 g
CA.GAZ.16.14.60	14		104	28.3	Ø16	27 g
CA.GAZ.20.20.60	20		125	36.1	Ø20	56 g
CA.GAZ.25.20.60			130	39.6	Ø25	59 g
CA.GAZ.32.20.60		140	48.1	Ø32	62 g	

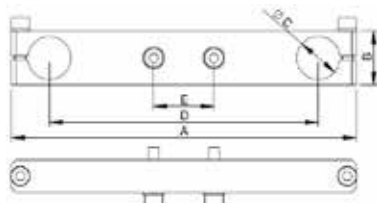

Bracket for Cylinder
 Adapter für Kompaktzylinder
 Staffa per cilindro
 Bride pour vérin
 Estribo para cilindro compacto

	A	B	C	D	E	M*	
CA.KBH.12.10.60	85	15	10	60	10	Ø12	33 g
CA.KBH.16.14.90	121	20	14	90	14	Ø16	56 g
CA.KBH.16.16.125	156	25	16	125			88 g
CA.KBH.20.14.90	121	20	14	90	17	Ø20	58 g
CA.KBH.20.16.125	156	25	16	125			90 g
CA.KBH.25.16.125					22	Ø25	94 g
CA.KBH.32.20.125	160		20		28	Ø32	156 g

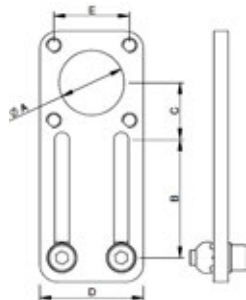
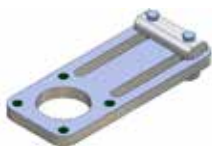

Bracket for Cylinder
 Adapter für Kompaktzylinder
 Staffa per cilindro
 Bride pour vérin
 Estribo para cilindro compacto

	A	B	C	D	E	M*	
CA.11.08.001.X	14	30	19.5	25	15.5	Ø12	35 g
CA.11.08.002.X	18				20	Ø16	
CA.11.08.003.X	22	40	19.3	35	25.5	Ø20	49 g
CA.11.08.004.X	28	35	24	40	28	Ø25	52 g
CA.11.08.005.X	32		27.5	45	34	Ø32	60 g



KHZ

	A	B	C	D	E	F	
CA.KHZ.20141005	Ø14	10	101,5	36	36	M5	135 g
CA.KHZ.20143005		30	141,5				250 g
CA.KHZ.32201518	Ø20	15	119,5	45	49.5	G1/8	399 g
CA.KHZ.32203018		30	149,5				483 g
CA.KHZ.32205018		50	189,5				602 g

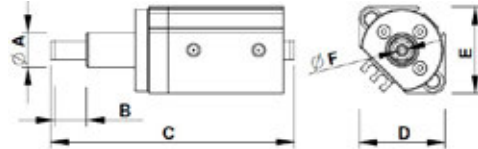

Compact cylinder for vacuum cup
 Kurzhubzylinder für Saugnapf
 Cilindro per ventosa
 Vérin compact pour ventouse
 Cilindro compacto para ventosa



JDR

	A	B	C	D	E	F	
CA.JDR.141005	Ø14	10	74,2	24	29	M5	54 g
CA.JDR.142505		25	119,2				76 g
CA.JDR.201005	Ø20	10	74,2	34	39	G1/8	63 g
CA.JDR.301518		15	87,2				112 g
CA.JDR.303018		30	130,2				150 g
CA.JDR.305018		50	190,2				200 g

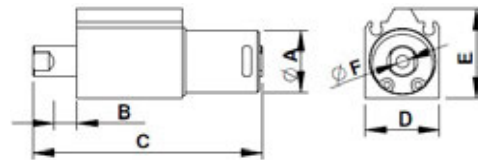

PMA

One finger, perpendicular acting, pneumatic grippers for clamping
 Pneumatische Einfingergreifer, mit senkrechter Bewegung
 Pinza perpendicolare per staffaggio
 Doigt de préhension pneumatiques perpendiculaires
 Pinza perpendicular para grapar

	Stroke	A	B	C	Gripping force (at 6 bar)	
CA.PMA.1406	6	14	M12X1	65	63 N	47 g
CA.PMA.2010	10	20	M17X1	89.9	115 N	115 g
CA.PMA.3015	15	30	M27X1	130.9	230 N	380 g